

## Zubehörkanal

Zubehörkanäle

Code: 3026 800



### EINZELHEITEN

Einbaurand Flächenbündig | FTS

Material Edelstahl AISI 304

Finish Spazzolato Foster

Textur Bürstung in Linie

Basis 120 cm

Außenmaße 1150 x 170 mm

Innenmaße 1122 x 142 mm

115 cm

Länge 8 einheit - Standard

Einbauöffnung

Siehe Datenblatt (für alle FT/FTS- und Unterbau-Modelle)

---

Serienmäßige Ausstattung

Befestigungshaken, Dichtung, Abfluss, im Karton verpackt

---

Abfluss

Abfluss 1 $\frac{1}{4}$ "

---

Schlüssel für das Zubehör

Die Längen der Kanäle und des Zubehörs werden in „Einheiten“ angegeben, für die Zusammensetzung muss die Summe der "Einheiten" des Zubehörs der Länge in "Einheiten" des Kanals entsprechen.

---

## MERKMALE

SPÜLBECKEN

Stahlstärke 1 mm. Eine beachtliche Dicke, die maximale Robustheit für Spülen garantiert, die die Zeichen der Zeit nicht kennen.

---

## TECHNISCHE DATEN

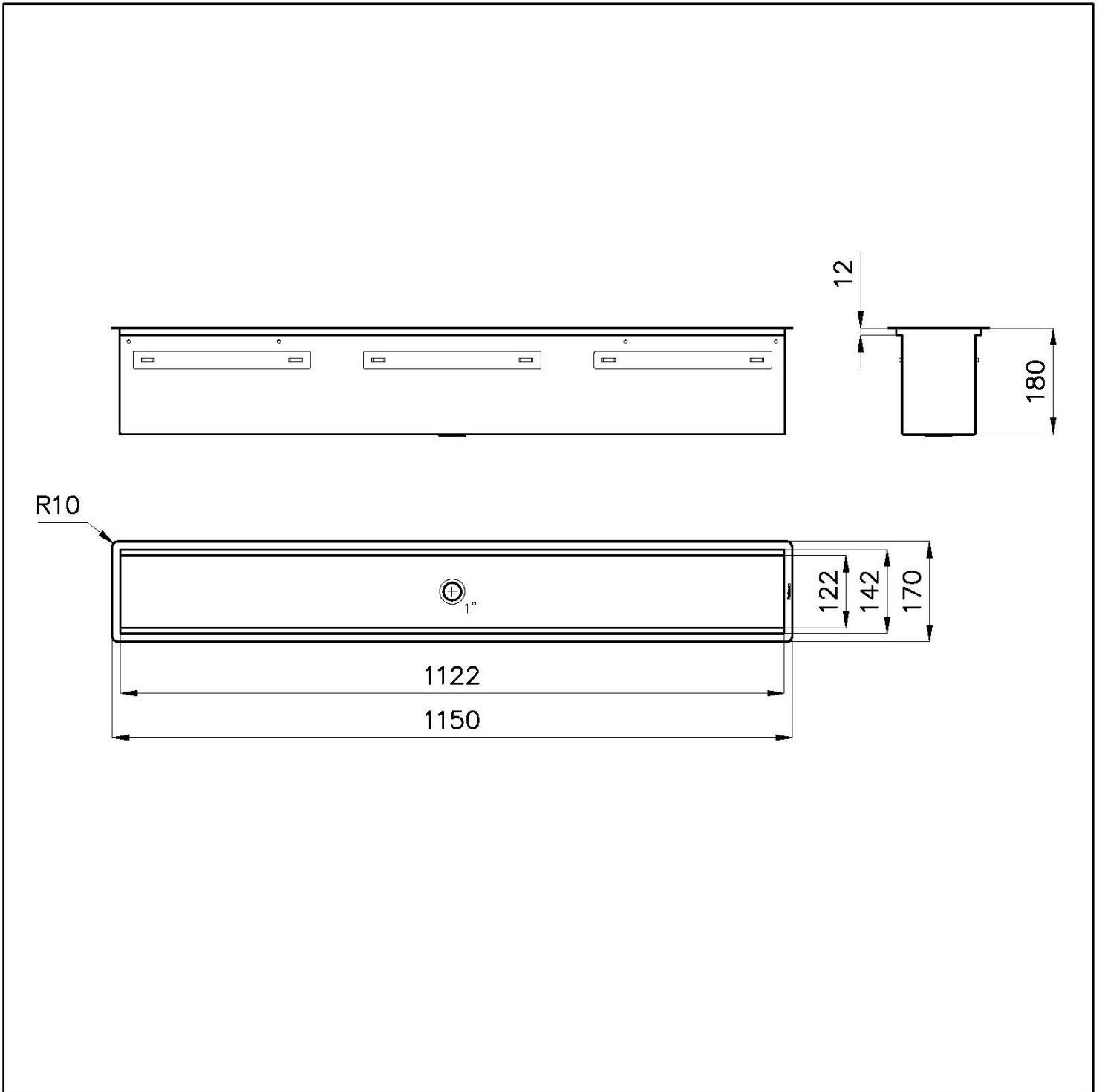

## Filotop/Flush-mount

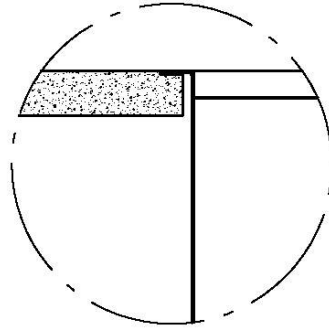

B-B:  
Dettaglio installazione  
Installation detail

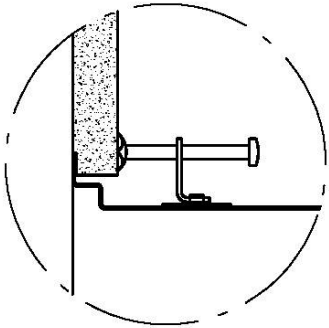

A-A:  
Dettaglio installazione e sistema di fissaggio  
Installation detail and fixing system

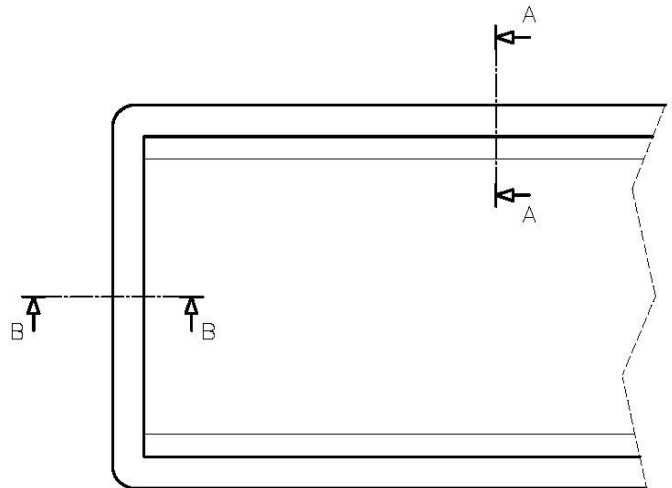

Dimensioni per foratura top  
Cut out size

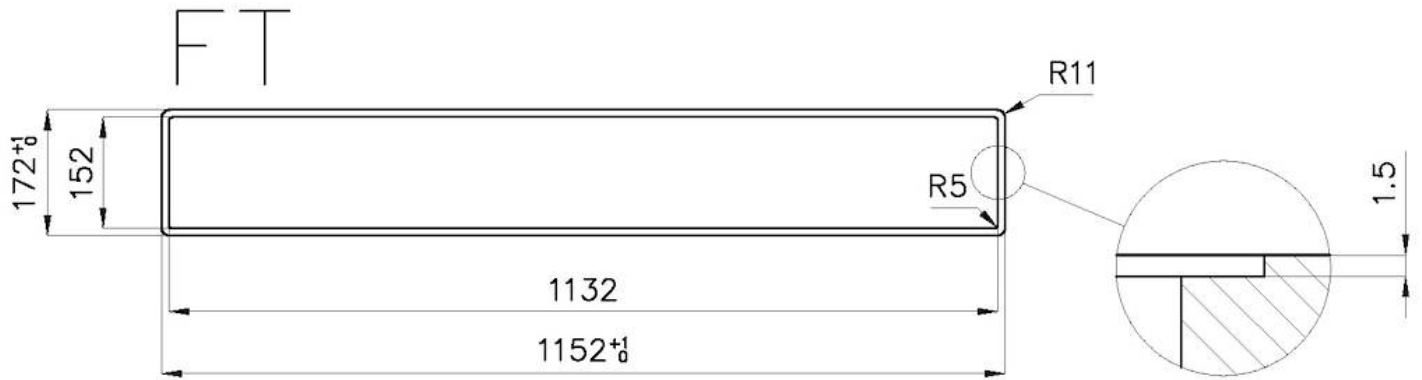

## GALERIE

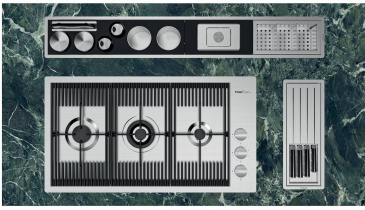

## OPTIONALES ZUBEHÖR



**Kit "A"**  
8100 703



**Kit "B"**  
8100 700



**Kit "C"**  
8100 701



**Kit "D"**  
8100 704



**Kit "E"**  
8100 705



**Kit "F"**  
8100 706



**Kit "G"**  
8100 710



**Kit "H"**  
8100 702



**Kit "N"**  
8100 714



**Perforierte Edelstahlwanne**  
8151 003



**Stainless steel knife holder**  
8100 712



**Steckdosenleiste aus Edelstahl**  
8000 020



**Tellerständer aus Edelstahl**  
1773 100